

Zweiteilige Pressarmatur – 90° mit Dichtkegel und O-Ring (DKO-L) metrisch, nach DIN 3865

Überwurfmutter leichte Baureihe

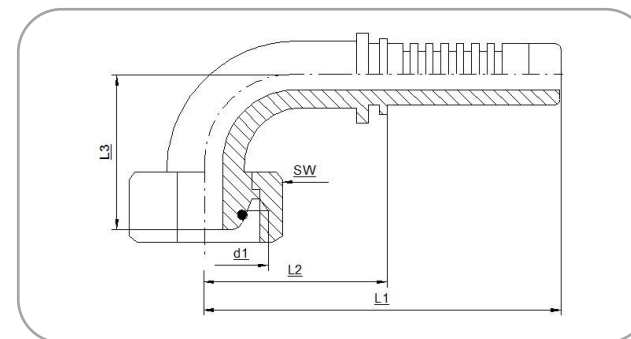

Passend für TECALAN-Schlauch Typ AF, BF, 250, BA, AS, AF...HH

Bezeichnung: P-Anschluss	DN	d1	SW	L1	L2	L3	Artikel-Nr.
5 DKO 12 - 6 L / 90°	5	M 12 x 1,5	14	52,0	27,0	28,0	S7630603
5 DKO 14 - 8 L / 90°	5	M 14 x 1,5	17	52,0	27,0	28,0	S7630803
6 DKO 14 - 8 L / 90°	6	M14 x 1,5	17	57,0	29,0	29,0	S7630804
6 DKO 16 - 10 L / 90°	6	M 16 x 1,5	19	57,0	29,0	30,0	S7631004
6 DKO 18 - 12 L / 90°	6	M 18 x 1,5	22	57,0	29,0	32,0	S7631204
8 DKO 16 - 10 L / 90°	8	M 16 x 1,5	19	59,0	31,0	33,0	S7631005
8 DKO 18 - 12 L / 90°	8	M 18 x 1,5	22	56,0	28,0	32,0	S7631205
10 DKO 18 - 12 L / 90°	10	M 18 x 1,5	22	61,0	31,0	33,0	S7631206
10 DKO 22 - 15 L / 90°	10	M 22 x 1,5	27	61,0	31,0	35,0	S7631506
12 DKO 22 - 15 L / 90°	12	M 22 x 1,5	27	70,0	37,0	38,0	S7631508

Werkstoff: Stahl, verzinkt, chromatiert (andere Werkstoffe auf Anfrage). Alle Maßangaben in mm.

Beethovenstr. 35D · 35410 Hungen / Hessen
 Telefon: +49(0)6402/512150
 Internet: www.tecalan.de

TECALAN