

Zweiteilige Pressarmatur – 90° mit Dichtkegel und O-Ring (DKO-S) metrisch, nach DIN 3865

Überwurfmutter schwere Baureihe

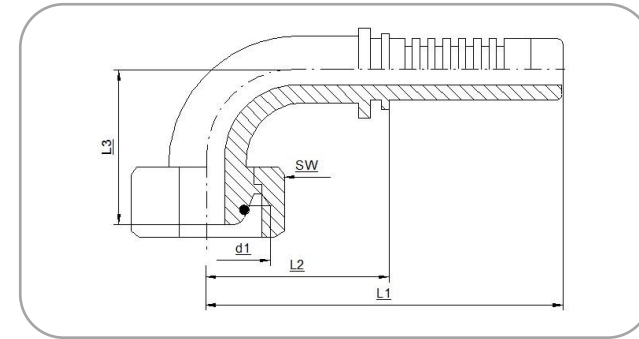

Passend für TECALAN-Schlauch Typ AF, BF, 250, BA, AS, AF...HH

Bezeichnung: P-Anschluss	DN	d1	SW	L1	L2	L3	Artikel-Nr.
5 DKO 14 - 6 S / 90°	5	M 14 x 1,5	17	52,0	27,0	28,0	S7730603
5 DKO 16 - 8 S / 90°	5	M 16 x 1,5	19	52,0	27,0	28,0	S7730803
6 DKO 16 - 8 S / 90°	6	M 16 x 1,5	19	57,0	29,0	29,0	S7730804
6 DKO 20 - 10 S / 90°	6	M 18 x 1,5	22	57,0	29,0	30,0	S7731004
8 DKO 18 - 10 S / 90°	8	M 18 x 1,5	22	59,0	31,0	33,0	S7731005
8 DKO 20 - 12 S / 90°	8	M 20 x 1,5	24	56,0	28,0	32,0	S7731205
10 DKO 20 - 12 S / 90°	10	M 20 x 1,5	24	61,0	31,0	33,0	S7731206
10 DKO 22 - 14 S / 90°	10	M 22 x 1,5	27	64,0	34,0	37,0	S7731406
12 DKO 22 - 14 S / 90°	12	M 22 x 1,5	27	71,0	39,0	41,0	S7731408
12 DKO 24 - 16 S / 90°	12	M 24 x 1,5	30	71,0	39,0	42,0	S7731608

Werkstoff: Stahl, verzinkt, chromatiert (andere Werkstoffe auf Anfrage). Alle Maßangaben in mm.

Beethovenstr. 35D · 35410 Hungen / Hessen
 Telefon: +49(0)6402/512150
 Internet: www.tecalan.de

TECALAN