

TECALAN

Zentralschmierung



Beethovenstr. 35D · 35410 Hungen / Hessen
Telefon: +49(0)6402/512150
Internet: www.tecalan.de

TECALAN

Typ ZS Schlauch



für Hochdruckanwendungen mit Mineralfetten für Schmieranlagen

- Verschleißfest und flexibel
- Geringes Gewicht
- Temperaturbereich:
 - -30°C bis +80°C
 - für Flüssigkeiten auf Wasserbasis und Druckluftanwendungen: max. +65°C

Sicherheitsfaktor von 4:1 bei dynamischen Anwendungen

Aufbau / Werkstoff:

Innenrohr aus Polyamid 6,
Textilgeflecht als Druckträger,
Ummantelung aus Polyurethan, geprickt.

Artikel-Nr.	Bezeichnung	DN	Innen Ø [mm]	Außen Ø [mm]	Betriebsdruck [bar]	Berstdruck [bar]	Min. Biegeradius[mm]	Gewicht [kg/100m]
24200501	ZS4	4	4,0	8,6	210 (dynamisch) 280 (statisch)	840	20	5,4

Eine Rolle Schlauch von 100 m kann aus max. 4 Längen bestehen. (100 m-Rollen ohne Trennstellen auf Anfrage)

Die angegebenen Daten beziehen sich auf Standard-Prüfbedingungen (23°C +/- 5°C)

Schraubhülse ZH4

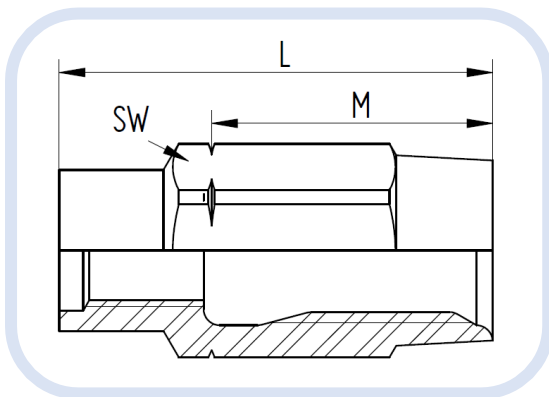

Artikel-Nr.	Bezeichnung: Schraubhülse	M [mm]	L [mm]	SW [mm]
41250021	ZH4	17,5	27	12

Werkstoff: Stahl

Oberfläche: Zink - Nickel

Rohrstutzen gerade

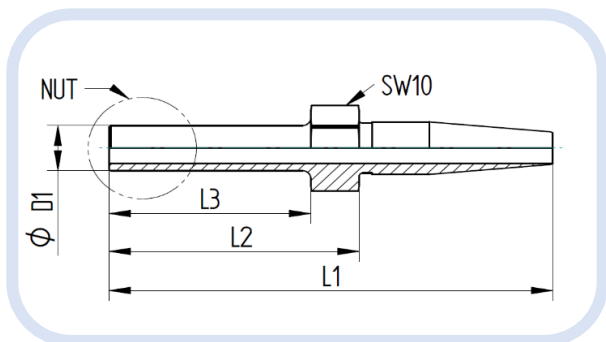

Artikel-Nr.	D1 [mm]	L1 [mm]	L2 [mm]	L3 [mm]	Nut
91253041	6	48	24	18	-
91253051	6	49,5	26	20	-
91253061	6	52	28	22	-
91253091	6	55	31	25	-
91253101	6	60	36	30	-
91253261	6	54	30	24	T1
91253271	6	60	36	30	T1
91253281	6	48	24	18	T2
91253291	6	60	36	30	T2
91253301	6	50	26	20	T3
91253311	6	52	28	22	T3
91253321	6	60	36	30	T3
91253531	6	56	32	26	TK
91253541	6	63	39	33	TK
91253551	6	99	75	69	TK

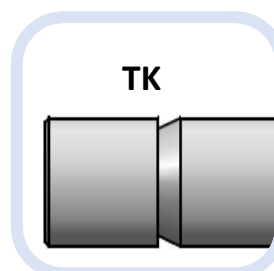
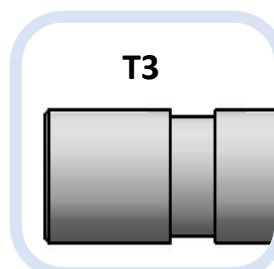
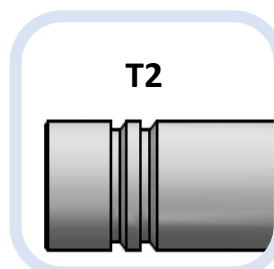
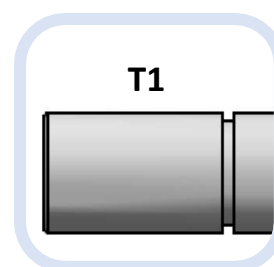

Werkstoff: Stahl

Oberfläche: Zink - Nickel

Achtung: Armaturen nur verwendbar mit Schraubhülse ZH4 (41250021)

Rohrstutzen 45°

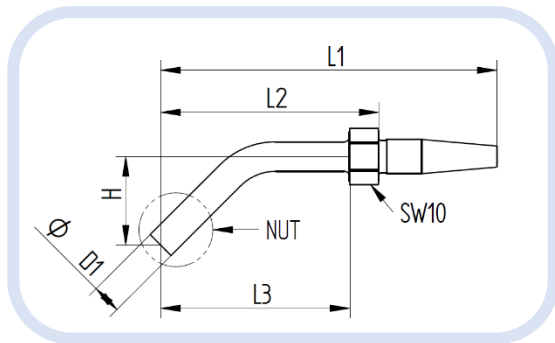

Artikel-Nr.	D1 [mm]	H [mm]	L1 [mm]	L2 [mm]	L3 [mm]	Nut
91255601	6,0	27,0	62,0	38,0	32,0	-
91255611	6,0	18,5	67,3	43,3	37,3	-
91255621	6,0	28,4	78,1	54,1	48,1	-
91255631	6,0	43,3	92,2	68,2	62,2	-
91253381	6,0	28,4	78,1	54,1	48,1	T1
91253391	6,0	28,4	78,1	54,1	48,1	T2
91253701	6,0	35,0	55	31	25,0	T3

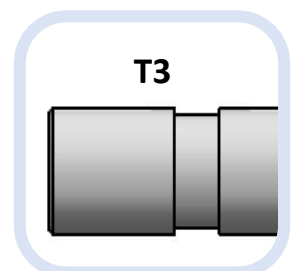
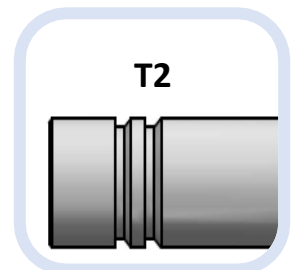
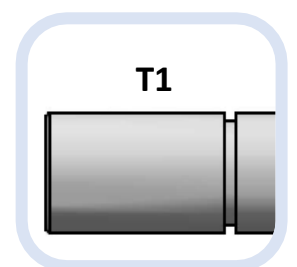

Werkstoff: Stahl

Oberfläche: Zink - Nickel

Achtung: Armaturen nur verwendbar mit Schraubhülse ZH4 (41250021)

Rohrstutzen 90°

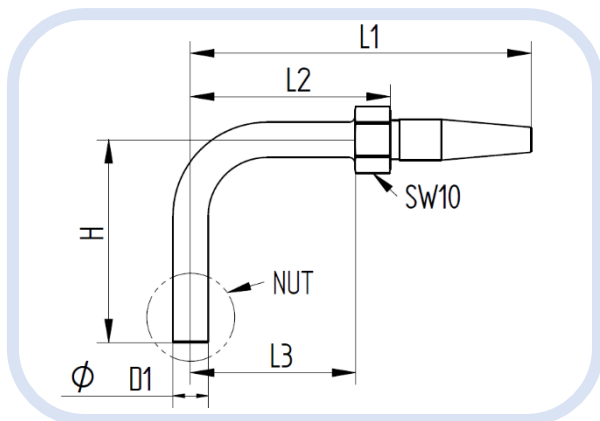

Artikel-Nr.	D1 [mm]	H [mm]	L1 [mm]	L2 [mm]	L3 [mm]	Nut
91253401	6,0	20,7	44,1	20,1	14,1	-
91253411	6,0	32,7	44,1	20,1	14,1	-
91253421	6,0	38,0	58,0	34,0	28	-
91253431	6,0	50,0	58,0	34,0	28	-
91253461	6,0	32,7	44,1	20,1	14,1	T1
91253471	6,0	38,0	58,0	34,0	28	T1
91253481	6,0	50,0	58,0	34,0	28	T1
91253491	6,0	32,7	44,1	20,1	14,1	T2
91253501	6,0	38,0	58,0	34,0	28	T2
91253511	6,0	50,0	58,0	34,0	28	T2
91253521	6,0	37,0	58,0	34,0	28	T3

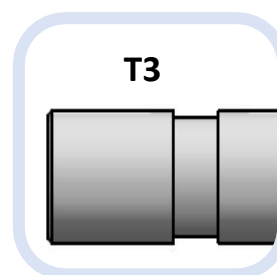
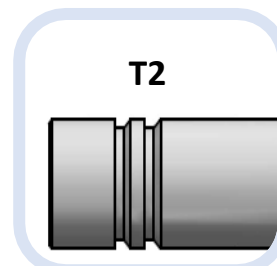
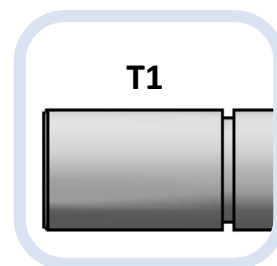

Werkstoff: Stahl

Oberfläche: Zink - Nickel

Achtung: Armaturen nur verwendbar mit Schraubhülse ZH4 (41250021)

TECALAN-Rohr in harter Ausführung

Nach DIN 73378

Material: PA12 HL

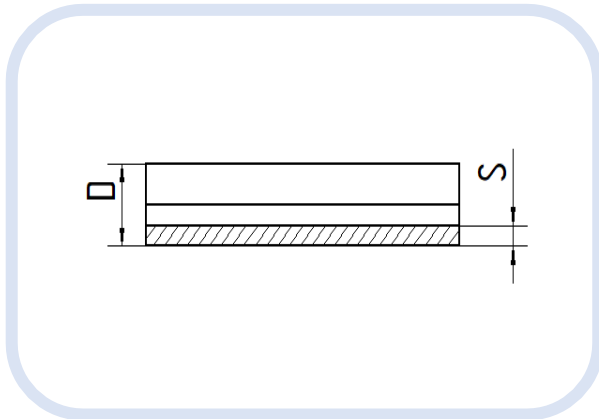

Bezeichnung	Farbe	Außen Ø (D) x Wandstärke (S) [mm]	Betriebsdruck [bar]	Biege radius [mm]	Fettfüllung	VPE ⁱ [m]	Artikel-Nr.
TR 6/3 hswlt	schwarz	6 x 1,5	89	min. 30	Nein	200	24604218
TR 6/3 hnf	transparent	6 x 1,5	89	min. 30	Nein	200	24604211

ⁱ Toleranz der Rollenlänge: +/- 2%